

Drop-In Drop-in bain-marie, air ventilated, with one well (3 GN container capacity)

ITEM # _____

MODEL # _____

NAME # _____

SIS # _____

AIA # _____

341010 (D03H3)

Drop-in bain-marie, air ventilated, with one well (3 GN container capacity)

Short Form Specification

Item No.

Designed to be positioned in flush installation providing improved cleanability and suitable for modern design installations. Designed to serve the food in gastronorm containers with a maximum height of 150mm. Electronic overheating protection. Digital control with temperature display with precise adjustment (0,1°C). Fully compliant HACCP digital controls include visible alarms. A constant flow of hot air circulating through the containers guarantees the correct food temperatures. Temperature uniformity and fast warm up time are guaranteed thanks to heavy duty armored heating elements and powerful radial booster fans. Cylindrical stainless steel air diffusers provides a constant air circulation. 90% faster preheating phase and no need for water (as traditional bain marie), reduces energy and water consumption. The system operates without water and ensures 35% energy efficiency when compared to standard bain-marie heating. Since the water is not needed to heat the well, the system guarantees easy of use and maintenance and there is no calcification of the resistances. No need extra connections for draining the waste water, less work during installation/maintenance. No water consumption means less operating costs. Wells in 304 AISI stainless steel with rounded corners to facilitate cleaning operations. The well is also equipped with a drain hole. 19mm thick glass wool isolated with galvanize sheet guarantees excellent well insulation to reduce energy dispersion. Food introduced at the correct temperature maintains its core temperature according to Afnor Standards.

Main Features

- Electronic overheating protection.
- Designed to serve the food in gastronorm containers.
- Precise temperature control and setting at 0,1°C .
- As standard the product comes with digitally controlled thermostat which is in line of HACCP norms and provides visual alarm as a warning of the increasing or decreasing temperatures.
- It is possible to transform one of the GNs to soup dispenser with the available accessory.
- Wells in 304 AISI stainless steel with drain holes and pipes and with rounded corners to facilitate cleaning operations.
- Suitable for GN 1/1 containers with a maximum height of 150 mm.
- A constant flow of hot air circulating through the containers guarantees the correct food temperatures. Temperature uniformity and fast warm up time are guaranteed thanks to heavy duty armored heating elements and powerful radial booster fans. Cylindrical stainless steel air diffusers provides a constant air circulation.
- Since the water is not needed to heat the well, the system guarantees easy of use and maintenance: there is no calcification of the resistances.
- No need extra connections for water, less work during installation/maintenance.
- CB and CE certified by a third party notified body.
- Designed to be positioned in flush installation providing improved cleanability and suitable for modern design installations.
- Available drop-in dimensions: 1, 2, 3, 4, 5, 6 GN.
- Food introduced at the correct temperature maintains its core temperature according to Afnor Standards.

Construction

- IPx4 water protection.
- Electronic control with temperature display.
- Well in 304 AISI stainless steel with rounded corners to facilitate cleaning operations. The well is also equipped with a drain hole.

Sustainability

- 19mm thick rock wool isolated with galvanize sheet guarantees excellent well insulation to reduce energy dispersion.
- 90% fast preheating phase and no need for water (as traditional bain marie), reduces energy and no water consumption.
- The system operates without water and ensures energy efficiency when compared to standard bain-marie heating.
- No water consumption means less operating costs.

APPROVAL: _____

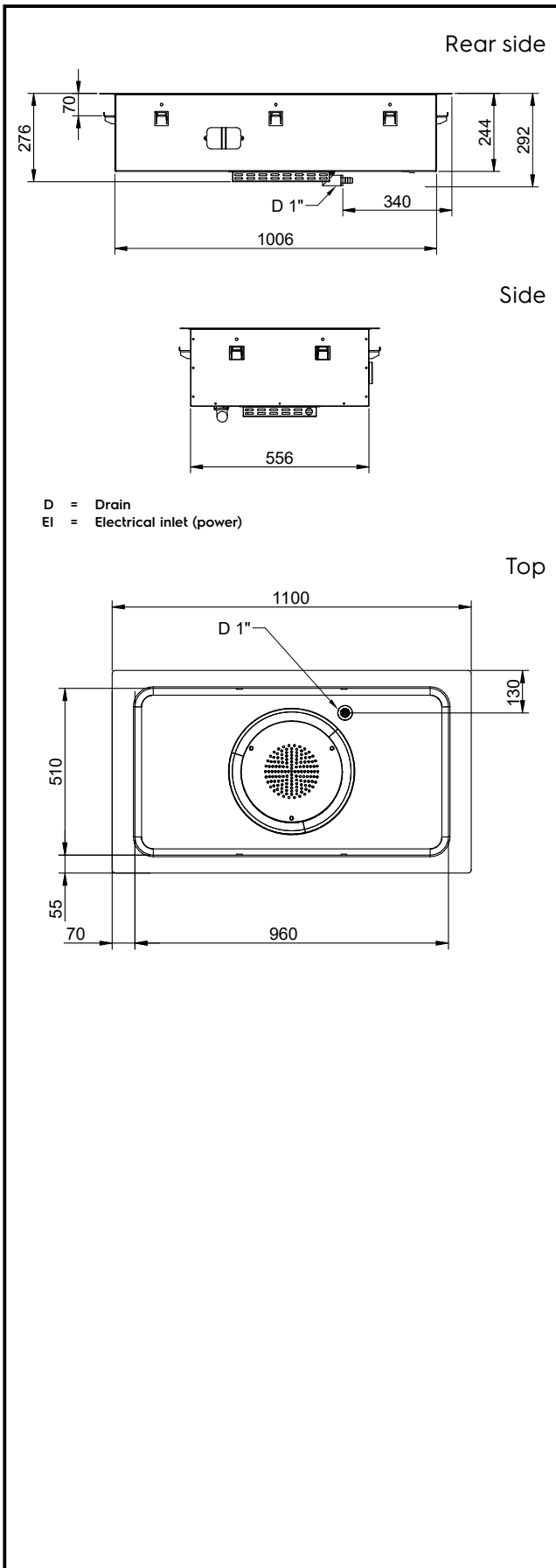

Electric

Supply voltage:

341010 (D03H3) 220-240 V/1N ph/50/60 Hz

Electrical power max.:

1.055 kW

Key Information:

External dimensions, Width: 1100 mm

External dimensions, Depth: 620 mm

External dimensions, Height: 276 mm

Net weight: 29.1 kg

Shipping weight: 50 kg

Shipping height: 720 mm

Shipping width: 670 mm

Shipping depth: 1140 mm

Shipping volume: 0.55 m³

Set temperature: +75 / +85 °C

Sustainability

Noise level:

59 dBA

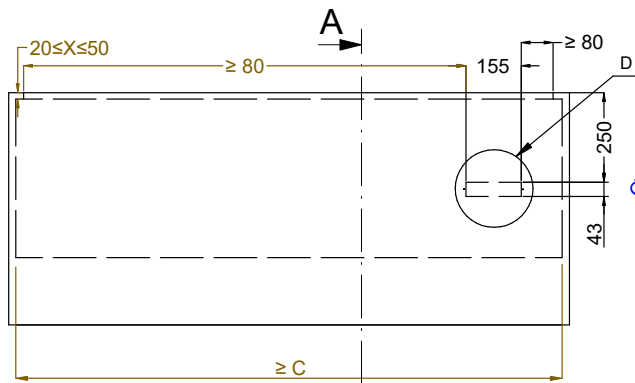

Front view
Scala: 1:10



Dettaglio D
Scala 1:7

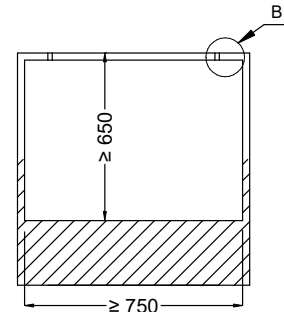

Section Cut A-A
Scala: 1:10

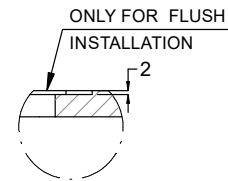

Dettaglio B
Scala 1:2

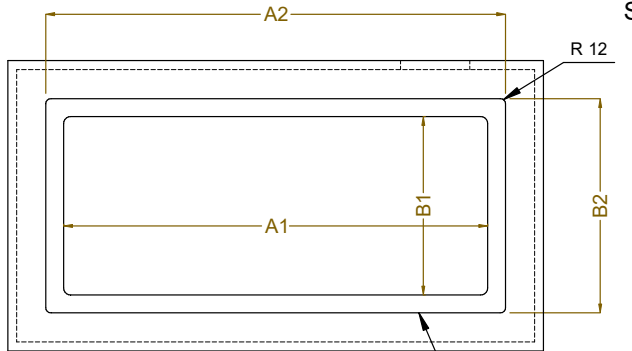

Top view
Scala: 1:10

CAPACITY	CUTOUT		LOWERING FOR FLUSH INSTALLATION		C
	A1	B1	A2	B2	
1GN	380	580	454	624	560
2GN	700		774		880
3GN	1030		1104		1200
4GN	1350		1424		1530
5GN	1670		1744		1850
6GN	2000		2074		2180

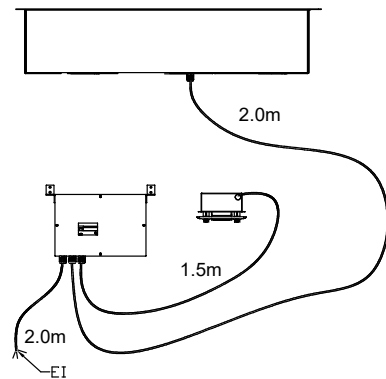
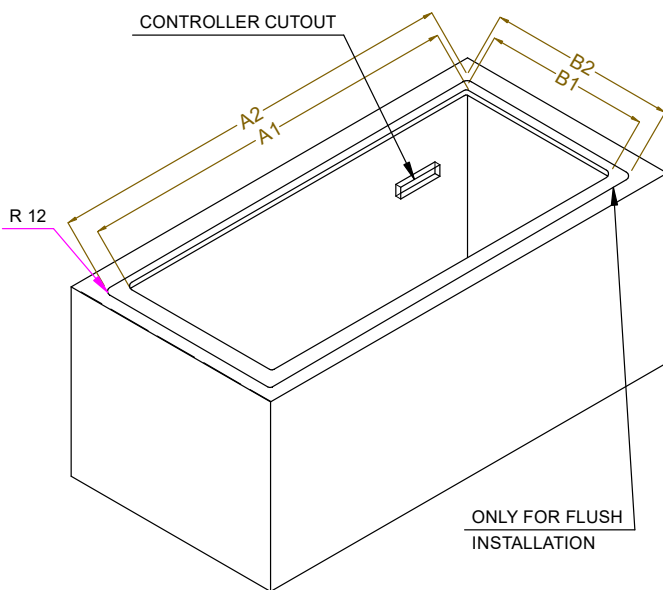

595T01L00 - AIR BAIN MARIE